

Angles on Parallel Lines (B) With Clues

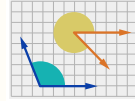

For each question calculate the missing angle and give a reason for your answer.

NOT TO SCALE

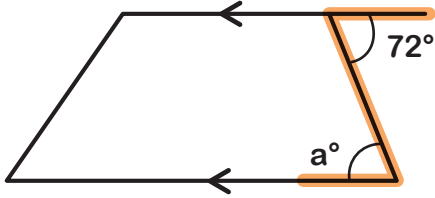

Angle a:	Reason:

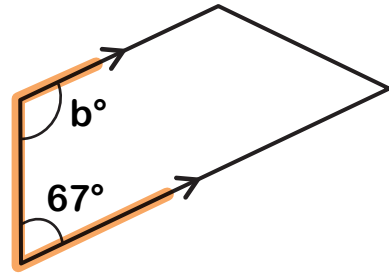

Angle b:	Reason:

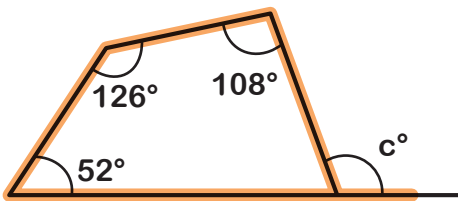

Angle c:	Reason:

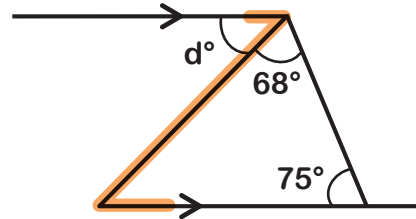

Angle d:	Reason:

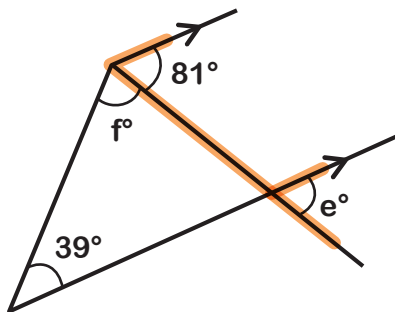

Angle e:	Reason:

Angle f:	Reason:

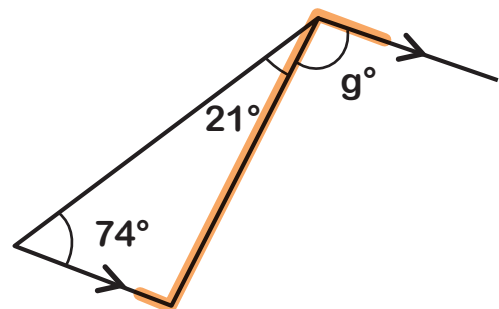

Angle g:	Reason:

Angles on Parallel Lines (B) With Clues

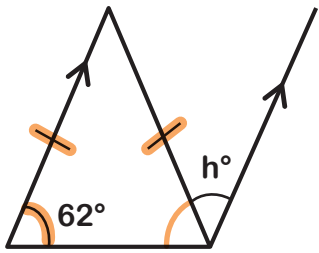
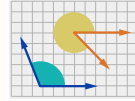

Angle h:	Reason:

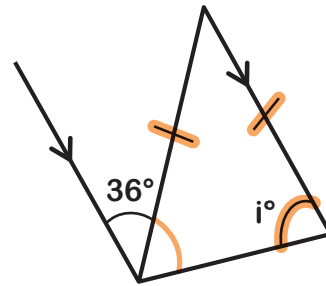

Angle i:	Reason:

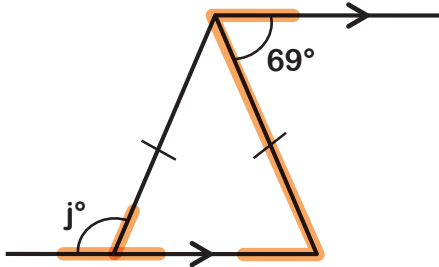

Angle j:	Reason:

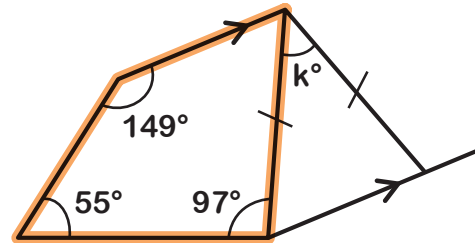

Angle k:	Reason:

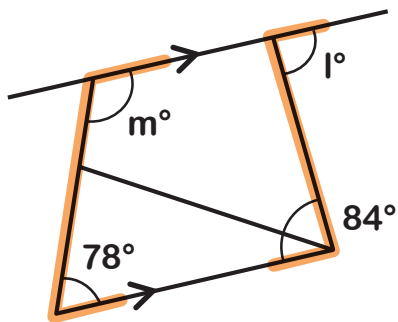

Angle l:	Reason:

Angle m:	Reason:

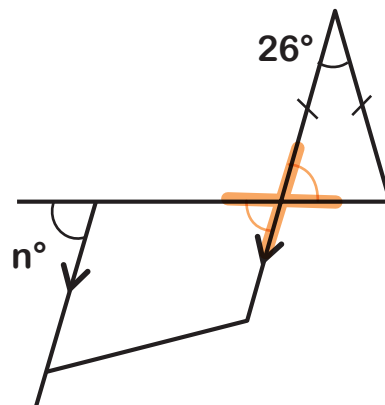

Angle n:	Reason: