

Name: _____

Year: _____

Date: _____



Finding the Missing Length from the Perimeter **ANSWERS**



Section A Find the missing length of the triangles

1) Perimeter = 12 cm

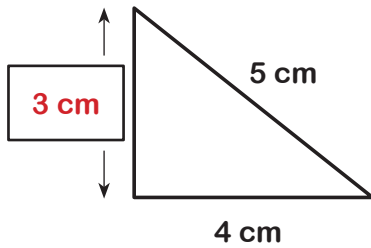

2) Perimeter = 23 cm

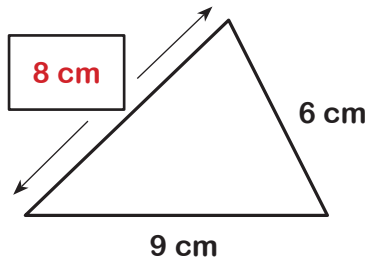

3) Perimeter = 24 cm

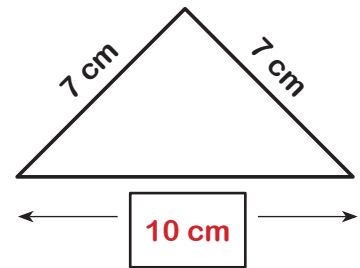

4) Perimeter = 22 cm

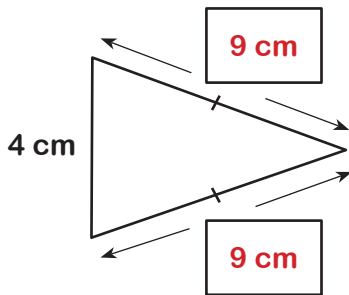

5) Perimeter = 32 cm

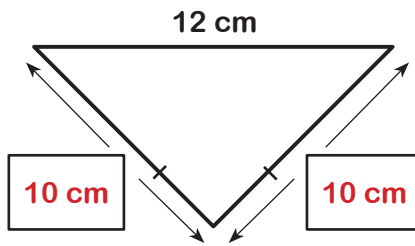

6) Perimeter = 18 cm

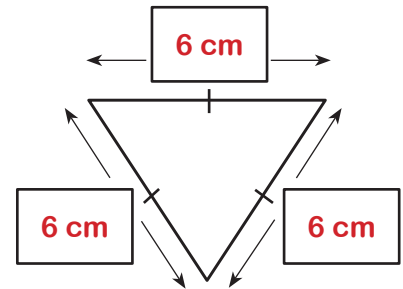

Section B Find the missing length or width of the rectangles.

1) Perimeter = 30 cm

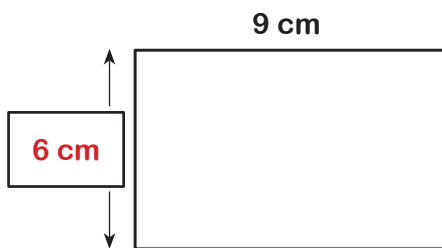

2) Perimeter = 24 cm

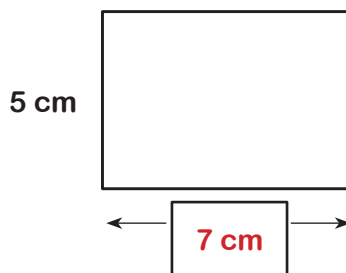

3) Perimeter = 26 cm

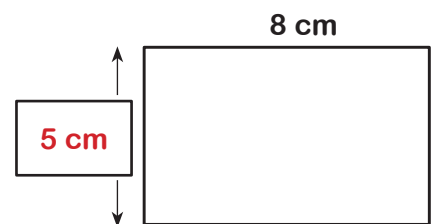

4) Perimeter = 56 cm

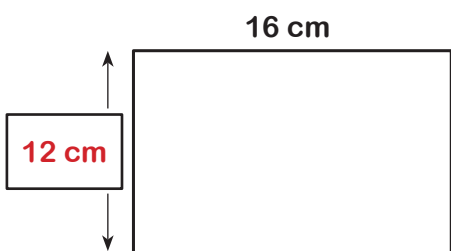

5) Perimeter = 24 cm

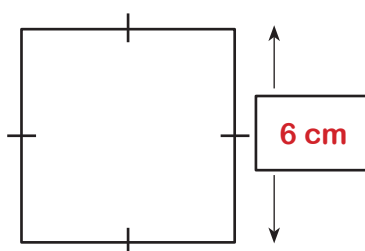

6) Perimeter = 36 cm

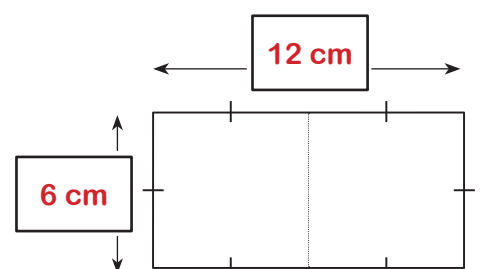



Finding the Missing Length from the Perimeter

ANSWERS



Section C Find the missing length of the shapes.

1)

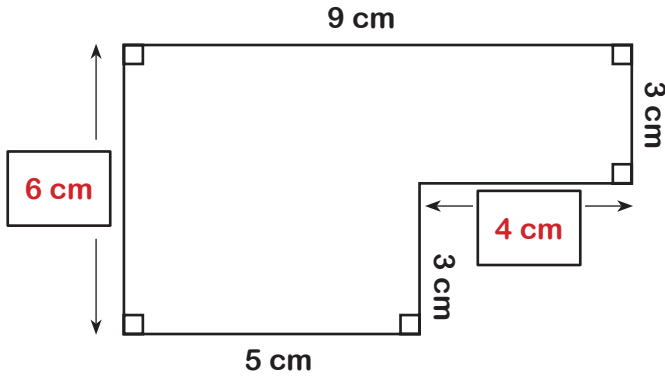

2)

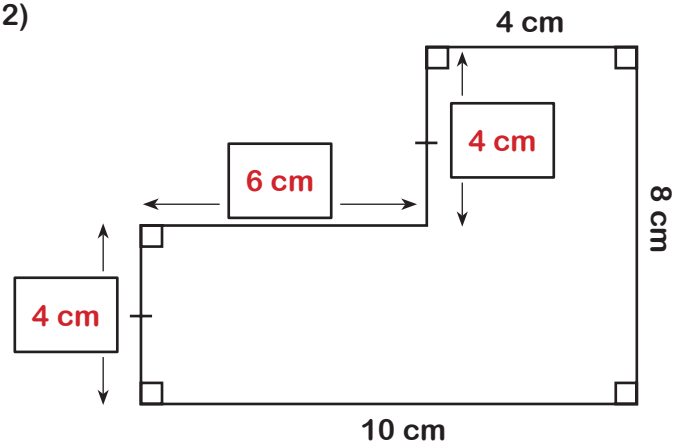

3) Perimeter = 28 cm

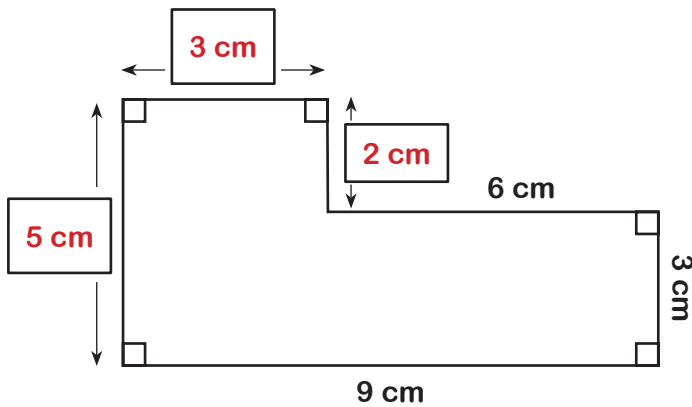

4) Perimeter = 36 cm

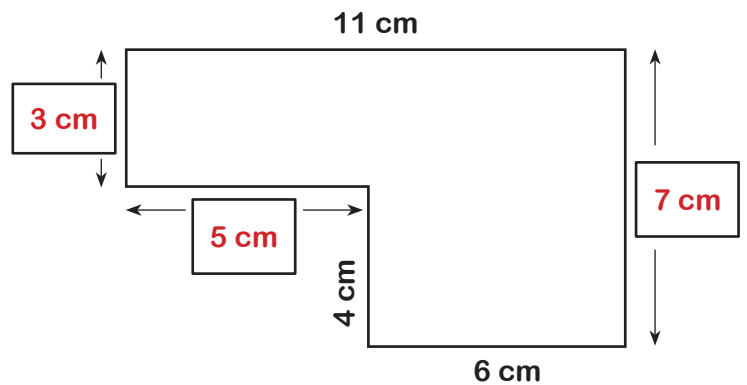

5) Perimeter = 34 cm

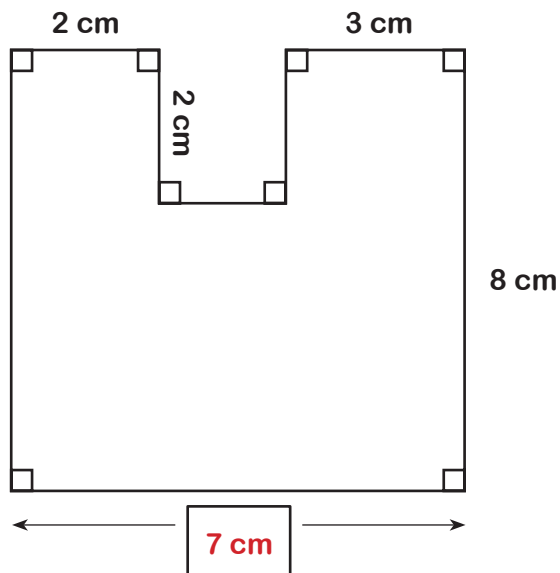

6) Perimeter = 48 cm

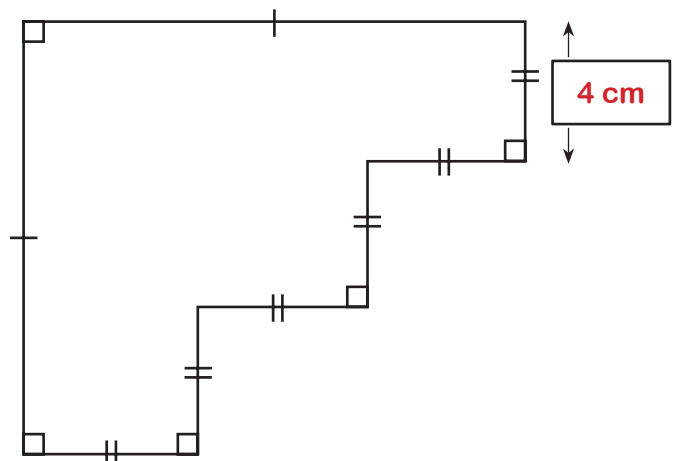

CHALLENGE